

Applications

- Photovoltaic testing
- Exposure testing
- Light bleaching
- High UV tests

Features

- Class ABA solar simulators
- Xenon short arc lamp
- Fully reflective optical system
- No chromatic aberration
- A variety of available filters
- Modular design
- Many optional components

Fully Reflective Solar Simulator

SS0.5k / SS1.0k / SS1.6k / SS2.5k



Fully Reflective Solar Simulator

OVERVIEW

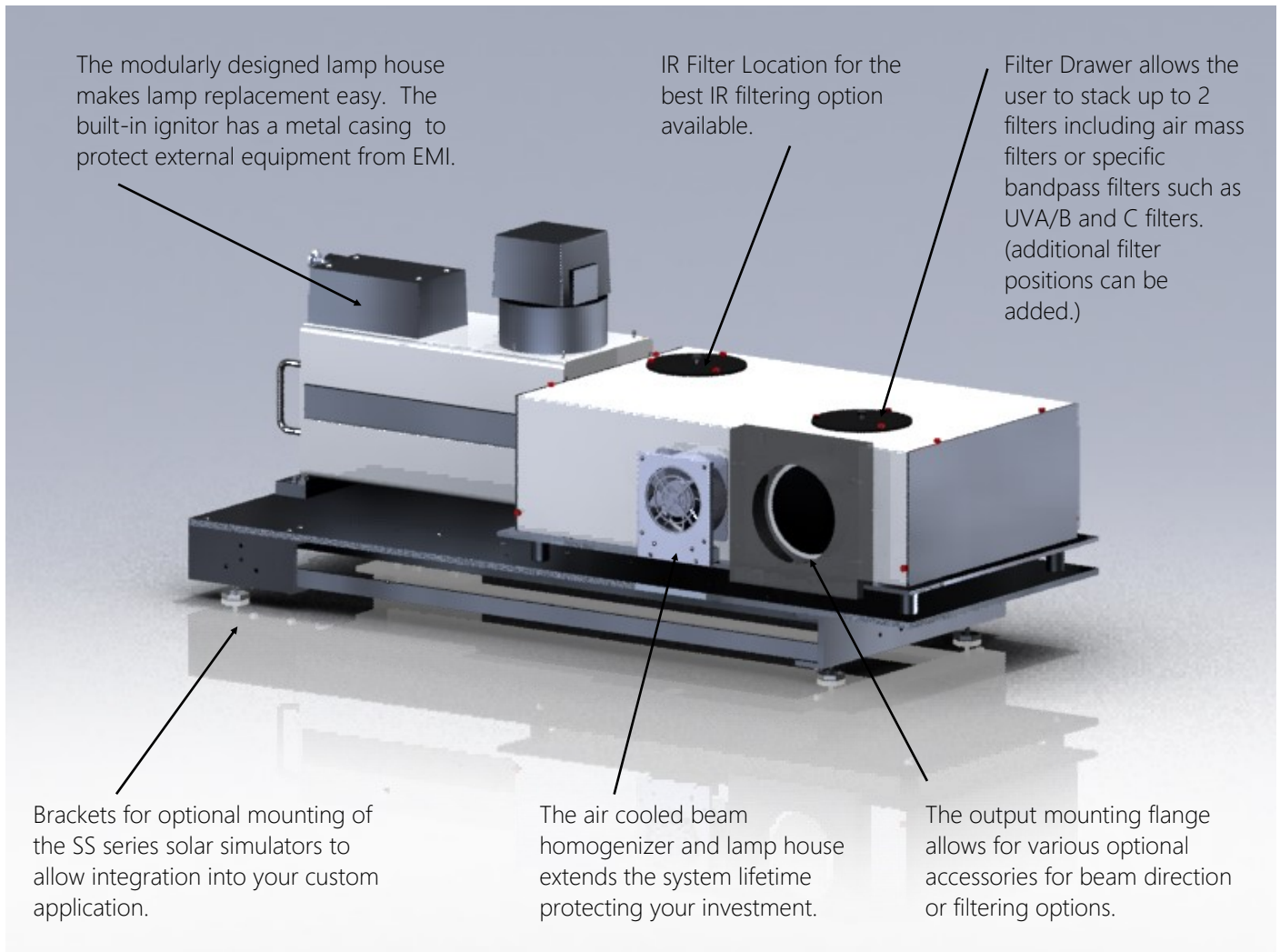

Sciencetech manufactures four high powered versions of Class ABA fully reflective solar simulators.

Sciencetech's proprietary fully reflective design uses metal coated mirrors and passes the whole spectrum, no compromise. This is a distinct advantage over refractive based systems that are limited by the properties of the transparent material used.

Fully Reflective Solar Simulator

SPECIFICATIONS

Models	SS0.5	SS1.0	SS1.6	SS2.5
Specification	165-9002	165-9001	165-9007	165-9008
Solar Simulator Type	Steady-State	Steady-State	Steady-State	Steady-State
Target diameter (mm) ¹	76.2	127	152.4	203.2
Target Diameter (mm) ¹ (with CTBT-SS or DFS-SS)	70	115	140	185
Beam Orientation ²	Horizontal	Horizontal	Horizontal	Horizontal
Working Distance (mm) ⁴	450	750	900	1050
Working Distance (mm) ⁴ (with CTBT-SS or DFS-SS option)	310	610	760	910
Solar Simulator Classification	ABA	ABA	ABA	ABA
Unfiltered Spectral Range (nm)	250-2500	250-2500	250-2500	250-2500
Spectral Match Classification ³	A	A	A	A
Spatial Non-uniformity ⁴ (%) ³	<5%	<5%	<5%	<5%
Spatial Non-uniformity Class ³	B	B	B	B
Temporal Instability Class ³	A	A	A	A
Temporal Instability (%) ³	Less 2%	Less 2%	Less 2%	Less 2%
Collimation half angle (deg) ⁶	< 3	< 3	< 3	< 3
Lamp Type	Xenon Short Arc	Xenon Short Arc	Xenon Short Arc	Xenon Short Arc
Lamp Power (W)	500	1000	1600	2500
Maximum Illumination Intensity ⁵	1 Sun	1 Sun	1 Sun	1 Sun
Simulator Dimensions (mm)	50x50x123	50x50x123	50x50x123	
Simulator Weight (kg)	55	55	55	
Control Unit Description	Integrated Touchscreen	Integrated Touchscreen	Integrated Touchscreen	Integrated Touchscreen
Control Unit Model	611-0.5k	611-1k	611-1.6k	621-2.5k
Lamp life (hours)	1000	1000	1000	1000

Notes

1: Determined at 1 Sun AM1.5G, measured against ASTM E927-10

2: With addition of CTBT-SS or DFS-SS the beam orientation can be rotated in 90 degree increments

3: Measured according to ASTM E927-10, measurements are reported for each system in a test report.

4: A variation of +/- 15% in working distance can be expected due to system alignment variability, the exact working distance determined for each system is reported in a test report.

5: Determined with a calibrated reference cell under AM1.5G illumination conditions.

6: Typically not measured for each system produced

Fully Reflective Solar Simulator Power Supply

Touchscreen Power Supply - 601

Each Fully Reflective series solar simulator comes with a 601-series power supply.



601-series power supply

Standard features included with Sciencetech's 601-series power supplies:

- Touchscreen interface
- Shutter and exposure control (if electronic shutter is supplied)
- Single connection for lamp power, cooling, and communication
- Lamp starts and timer log
- Fan cooling safety interlock

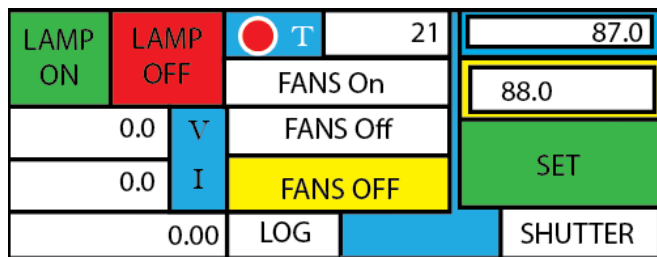

601-series touch screen power supply main control screen

Electronic Shutter Control

This shutter can be used with any high powered light source and can effectively block a 4" diameter beam.

This device is computer controlled through Sciencetech's line of Touch Screen power supplies

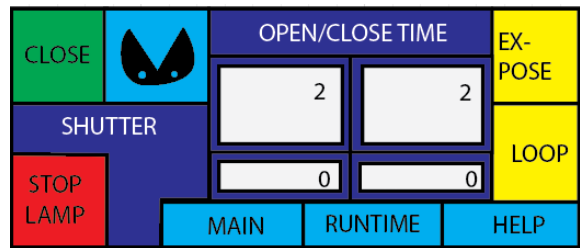

Software Included

Fully Reflective Solar Simulator come with SciLampPower Control.

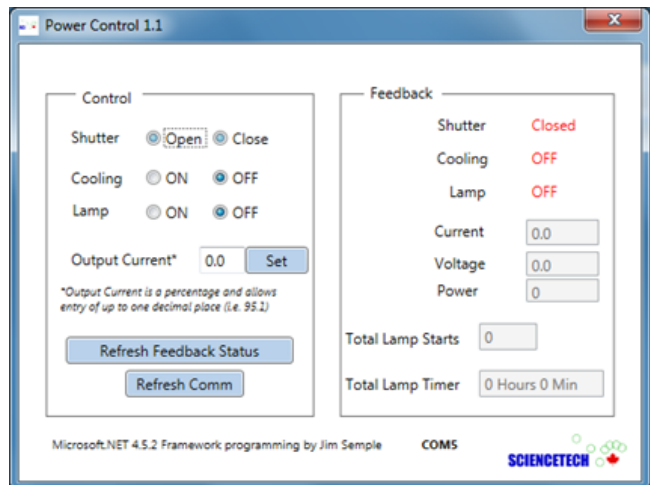

Software GUI for power supply control

Fully Reflective Solar Simulator

CONFIGURATION

Sciencetech's fully reflective solar simulators can be configured to suite your requirements.

The homogenizer can be customized to include a computer controllable shutter, or a variable focus option that lets you position the uniform plane at different working distances from the output of the simulator.

Numerous filtering options are available. Some filter options are added to the beam line through the built in filter drawer. Other filtering options require the addition of a beam turning filter holder.

A range of solar cell chucks with options such as vacuum clamps, thermoelectric or water cooling, micropositioners as well as complete IV testing software and hardware are also available.

The SS0.5k through SS1.6k models can be mounted on a vertical stand for downward facing operation. Note that the SS2.5k model must be mounted on a table for downward facing operation.

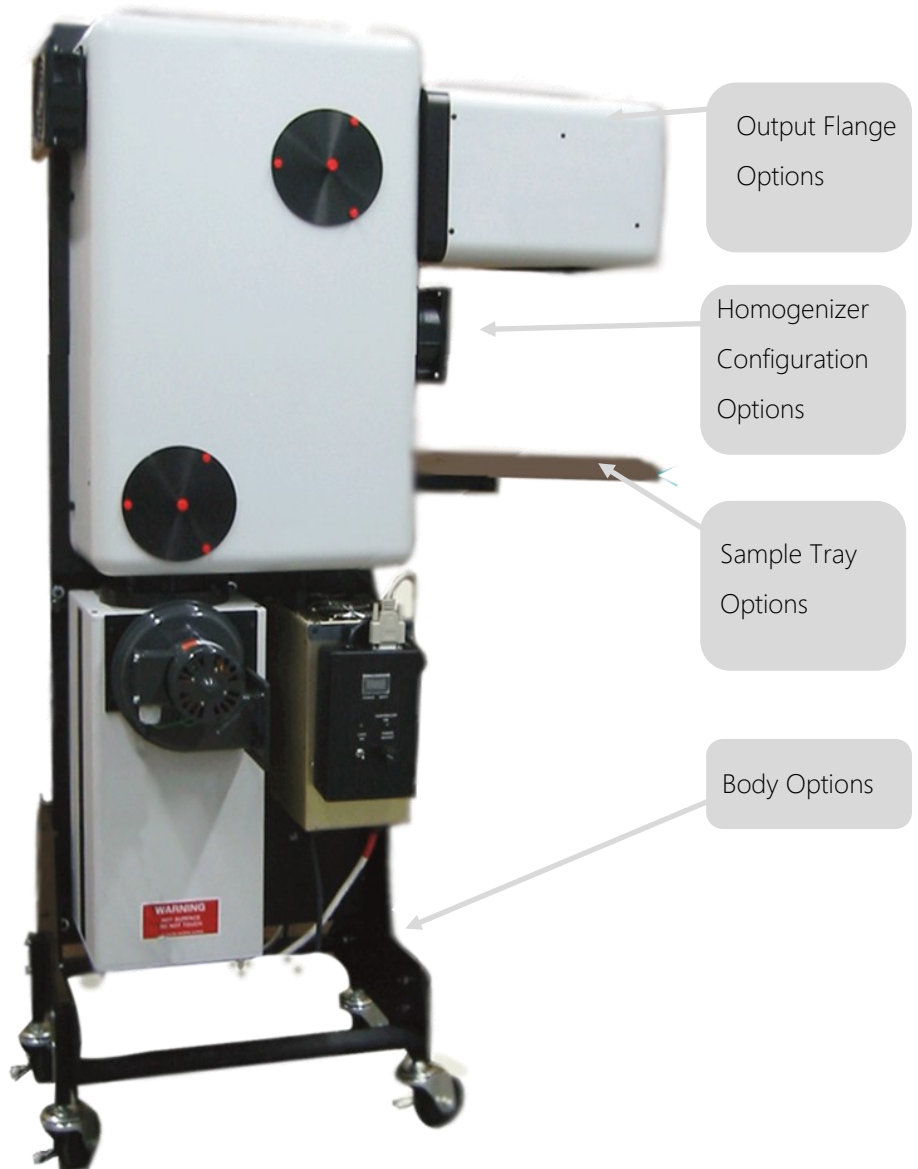

Fully Reflective Solar Simulator

ACCESSORIES



SHUTTER

(165-8005)

High Power Computer Controlled Shutter

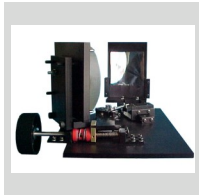

Solar Simulator Variable Focus

(165-8011)

Variable Focus. Vary illumination intensity or concentrating the light into a smaller area.

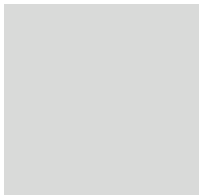

G1 Quartz

Contact

Homogenizer output window (G1 Quartz) for sealed homogenizer option



IV Measurement System

Contact

20W IV Tester for Continuous Solar Simulators (current range = 1 A, voltage range = 200 V). Sciencetech Software is included.



Output Flange Option (CTBT-SS)

(165-8018)

Beam turning mirror

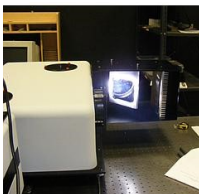

Output Flange Option (CTBT-RF)

(165-8034)

Dichroic beam turning assembly

Fully Reflective Solar Simulator

ACCESSORIES



Body Option (BASE-SS)

(165-8030)

Base assembly for vertical stand



Body option (BASE-SS-ROLL)

(165-8048)

Solar simulator base assembly with casters

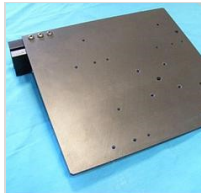

Sample Tray Option (SAMP-STD)

(165-9006)

Standard solar simulator sample plate and clamp assembly

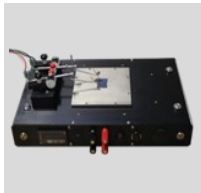

Chucks

[Browse Chucks](#)

A range of solar cell chucks and sample cooling and holding accessories are available



(DFS-SS)

(165-8050)

Downward facing stand package for SS2.5k.



Dark Safety glasses

(720-0159)

UV Dark safety glasses.

Fully Reflective Solar Simulator

Filter Options

Each Sciencetech fully reflective solar simulator includes an FH-SS filter tray. The FH-SS filter tray holds up to 2 filters and is located in the simulator's beam homogenizer. An additional two filter slots can be added by adding product (FH-SS-ADD) to your order.

Item Number	Description
Spectral Filters - Near 0 degree incidence - 3" diameter, mounted in FT filter mount	
MF-34-FT-3	75mm Mesh 34% Neutral density Filter with Holder
MF-49- FT-3	75mm Mesh 49% Neutral Density Filter with Holder
MF-71-FT-3	75mm Mesh 71% Neutral Density Filter with Holder
HPF-BB-NIR-FT-3	Hot Mirror for UV Applications
HPF-LP-UVA-FT-3	Visible longpass filter
HPF-BB-UVB-FT-3	UVB band blocking filter
HPF-BP-VIS-FT-3	Visible bandpass filter, 0 Deg
HPF-LP-420-FT-3	420 nm longpass filter



Air mass filters - near 0 degree incidence	
AMF-AM0	Air mass AM0 Filter for SS Series Solar (Standard Range)*
AMF-AM1.5D	Air mass AM1.5D Filter for SS Series Solar (Standard Range)
AMF-AM1.5G	Air mass AM1.5G Filter for SS Series Solar (Standard Range)
<i>* Using AM0 filter reduces the target size achievable for 1 sun class A</i>	



Homogenizer IR Water Filter	
100-8018	IR water Filter, 3" Stainless Steel, Fused Silica Windows

Beam turning filters - 45 degree 0 used with CTBT- RF	
640-8004	Pass VIS, Block UV, IR - CTVT option
640-8008	Pass IR, Block UV Block VIS
640-8011	Pass UVA+B, Bk VIS+IR-CTBT option

Fully Reflective Solar Simulator

DIMENSIONS

Dimensions of SS2.5k (Mounted on DFS-2.5SS) are in [CM].

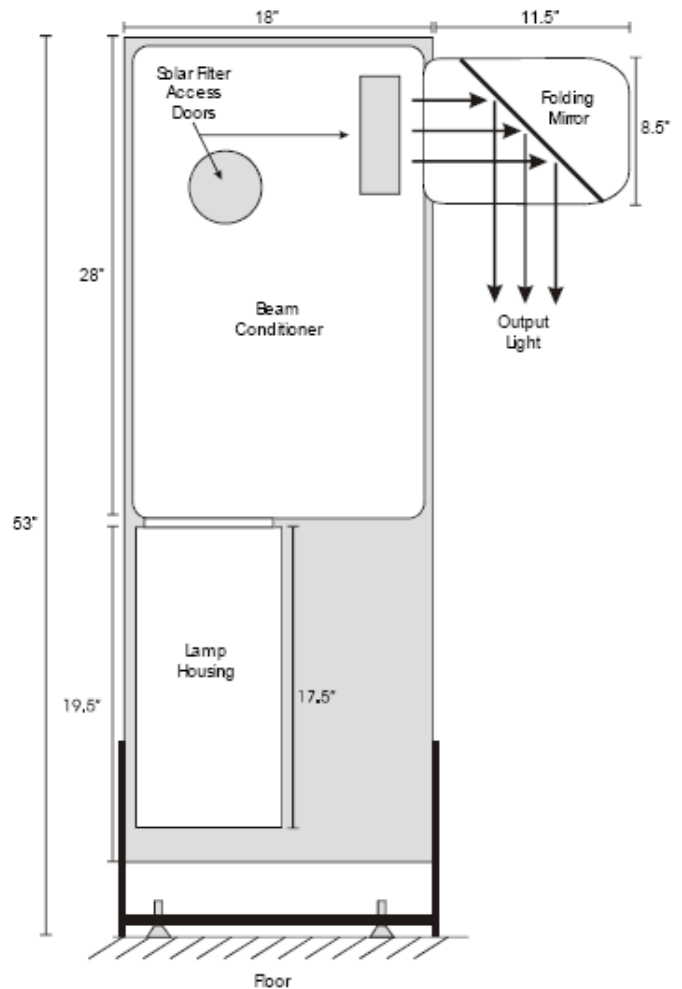
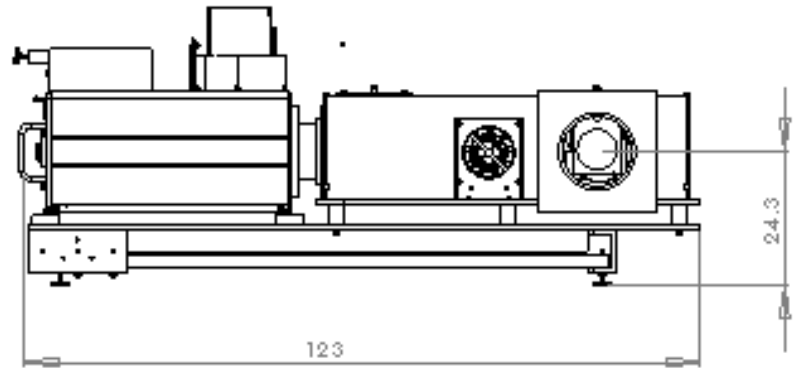
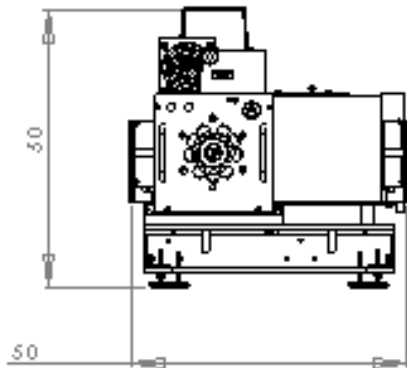

Fully Reflective Solar Simulator

DIMENSIONS

Dimensions of SS2.5k (Mounted on DFS-2.5SS) are in [CM].

