

SCIENCETECH

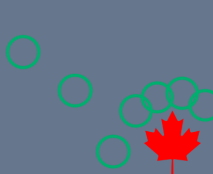

Success Story

European Space Agency –691



Sciencetech

Sciencetech Inc. (SCI) has been designing and manufacturing optical spectroscopy instruments in Canada since 1985. Sciencetech instruments have been used in many applications and fields including medical research, biotechnology, space sciences, analytical chemistry, material research, pharmacology, applied physics, aerospace, food sciences, drug discovery, cosmology, photodynamic therapy, security, and environmental and academic research.

Sciencetech's in-house team of designers and engineers have decades of combined experience in the fields of optical spectroscopy and solar simulation. Sciencetech's low-volume manufacturing combined with this expertise makes the company an ideal choice for custom instrumentation that goes beyond off-the-shelf needs.

European Space Agency

The European Space Agency (ESA) states its purpose to be to provide for, and to promote, for exclusively peaceful purposes, cooperation among European States in space research and technology and their space applications, with a view to their being used for scientific purposes and for operational space applications systems.

The Planck spacecraft's main objective is charting of the Cosmic Microwave Background (CMB). The CMB preserves a picture of the Universe as it was about 380 000 years after the Big Bang, and can reveal the initial conditions for the evolution of the Universe. Planck's main objective is to measure the fluctuations of the CMB with an accuracy set by fundamental astrophysical limits. The spacecraft will chart the most accurate maps yet of the CMB. [Source](#)

Planck & Sciencetech

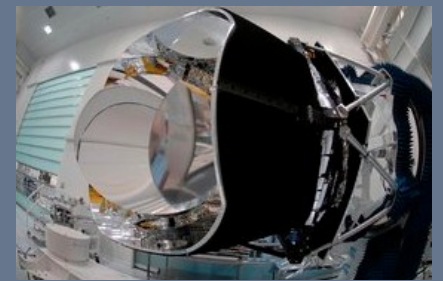

Initial Requirements

The Planck satellite has two instruments for detecting Cosmic Microwave Background (CMB) radiation: the Low-Frequency Instrument (LFI) and the High-Frequency Instrument (HFI).

The HFI is composed of 6 spectral photometric channels covering the range from 3 cm^{-1} to 30 cm^{-1} . The focal plane is constituted of 48 detectors of bolometric type cooled down to 100mK, each one associated with a set of wave-guide horns and filters.

Spectral calibration of the HFI was an essential component of the Planck project. Sciencetech was engaged for the second part of the calibration, the global characterisation of optical chains during the calibration of the integrated focal plane with the complete set of detectors. This stage dealt with a qualification model and a flight model of the focal plane. The calibration was carried out in Orsay in the calibration facility of the Institut d'Astrophysique Spatiale (IAS).

Sciencetech provided two Fourier Transform Spectrometers. The first spectrometer was configured with its own detection system and operated in an autonomous way. It constituted the "Stand-alone" FTS (SFTS, not shown). The second spectrometer (CFTS, below) was used as a spectrally modulated source, optically coupled with an integrating sphere placed in a cryogenic tank at 2 K ("Saturne" cryostat, allowed attainment of background radiation corresponding to a 2K blackbody). A source selector allowed selection of the CFTS source or an additional broadband source (BLG, below).

PLANCK-HFI LINE FTS

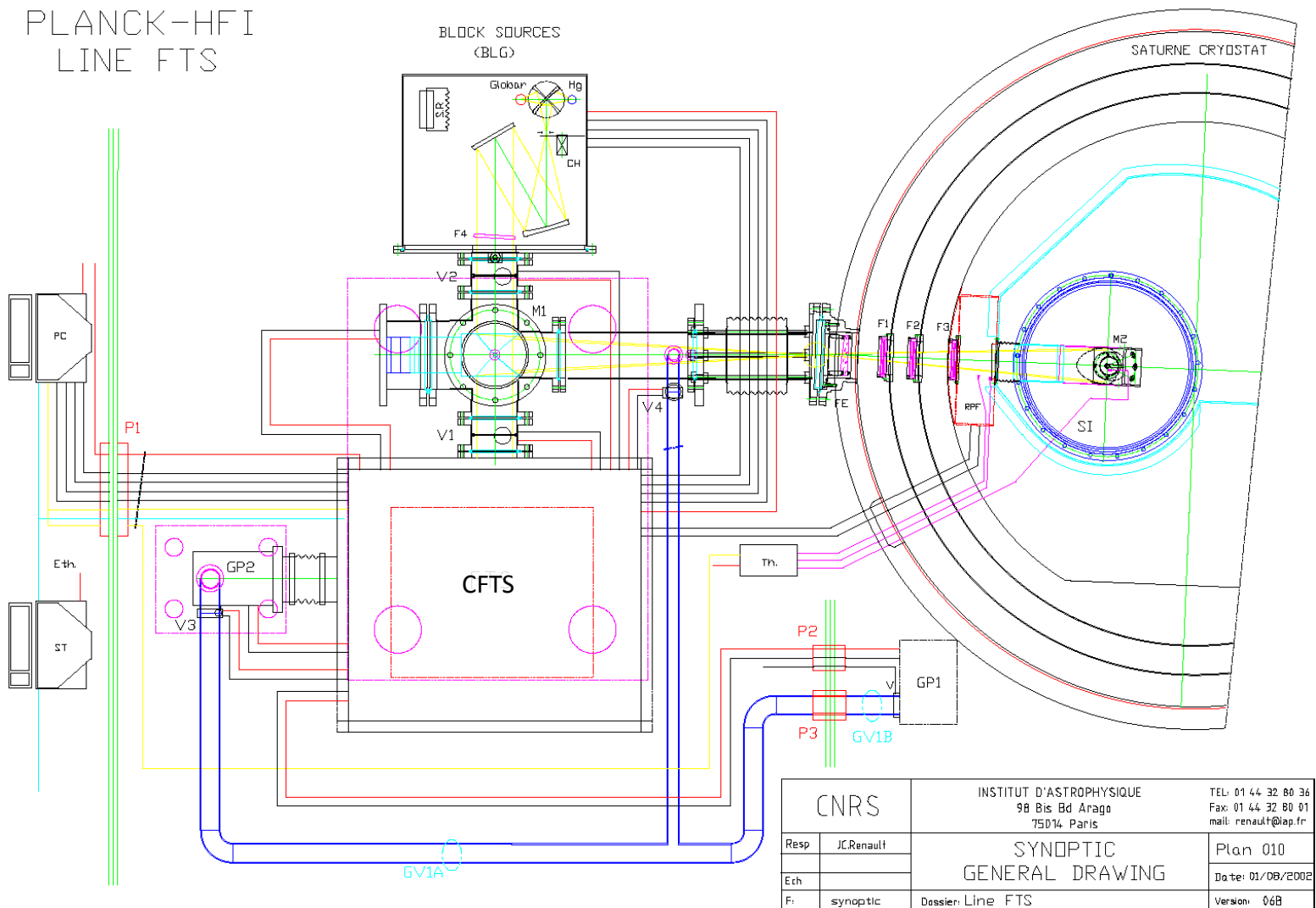

Design — Plan — Build — Test

Design

Sciencetech, working closely with ESA, customized its standard Fourier-Transform Infrared Spectrometer and integrated all third party components to achieve the system specifications.

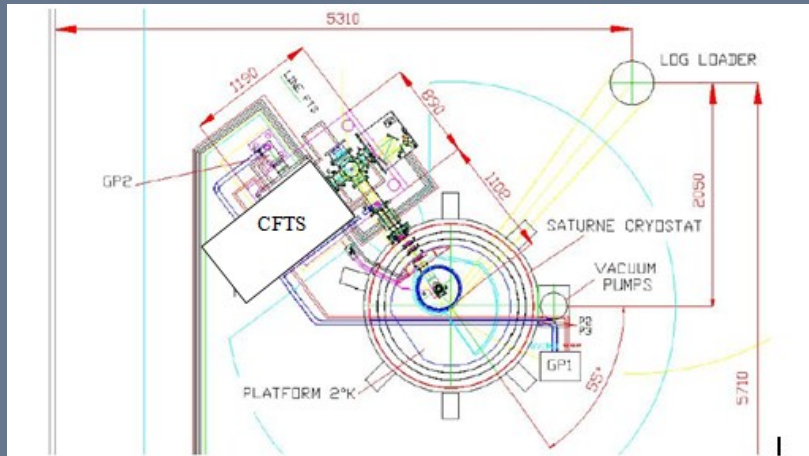

Plan

Working on a multi-national project as large as ESA's Planck satellite, scheduling and planning are key to ensure all key components come together at just the right time.

Sciencetech Scheduled its activities closely with ESA:

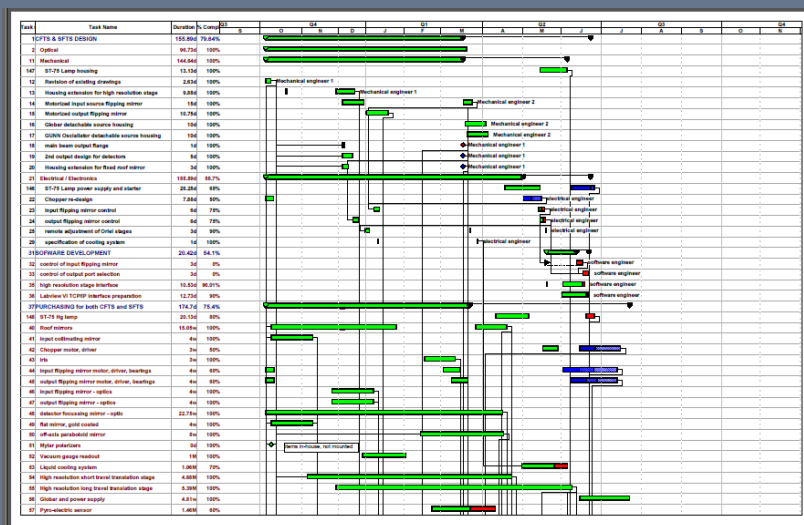

Measures

Sciencetech Inc. knows that quality and price guarantee as well as prompt delivery are vital requirements for our customers.

With rapid development of new solutions and strong interaction with the end user, we ensure equipment meets the needs of the end user's application, allowing new and innovative projects to move forward with our custom solutions.

Sciencetech's in-house design team has the experience and expertise to design in both 2D and 3D CAD models where we interact both in detailed isometric drawings or collaborative shared 3D files in the format that works for you.

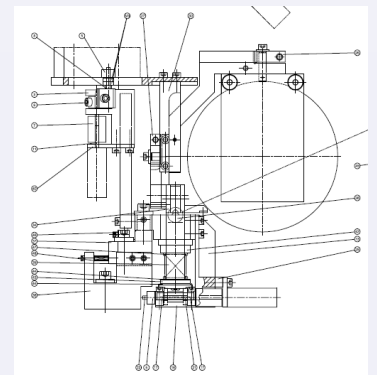

Build

Any project dealing with vacuum and clean rooms requires a strict process control to eliminate sub-micron airborne contaminants. These contaminants are generated by people, processes, facilities, and equipment. Sciencetech staff are trained in procedures to utilize the in-house ISO 6 (US Fed Std 209E class 1000) clean room for all assembly and equipment testing.

Utilizing these capabilities, all materials were chosen to ensure compliance with ESA's ISO 5 (US Fed Std 209E Class 100) clean room. Strict QC / CA practices were followed during the assembly, testing, and shipping phases to ensure Sciencetech's equipment complied with ESA's standards.

With most space projects, components are required to operate in a high vacuum environment. Sciencetech followed proper material selection, manufacturing, and cleaning procedures to ensure all internal components in the system met the strict quality requirements allowing them to perform in a vacuum of 1×10^{-6} Torr when coupled to ESA's cryostat system.

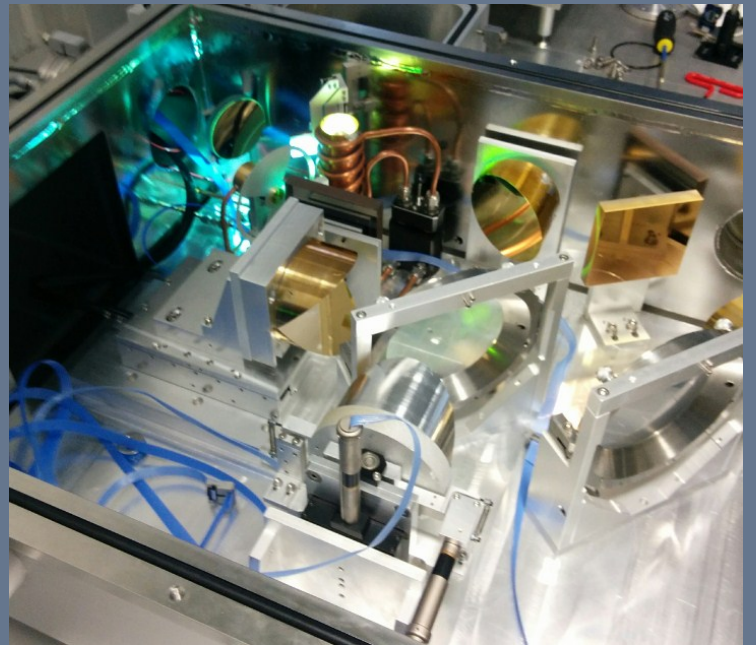
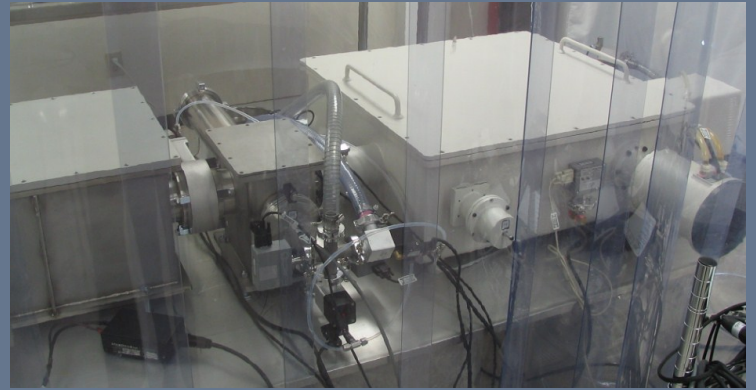

Verification and Test

Sciencetech, working with ESA, created a Verification and Test plan during the design processes. Following strict guidelines, test and verifications were done prior to acceptance and shipping.

One example test (right) shows that the SFTS reaches its resolution limit of 0.034 cm^{-1} .

This sample measurement was carried out using a germanium sample brought by an IAS (Institut Aeronautique et Spatial) delegation, yielding good results and demonstrating that the spectral reflectance and transmittance of solid samples can be readily acquired.

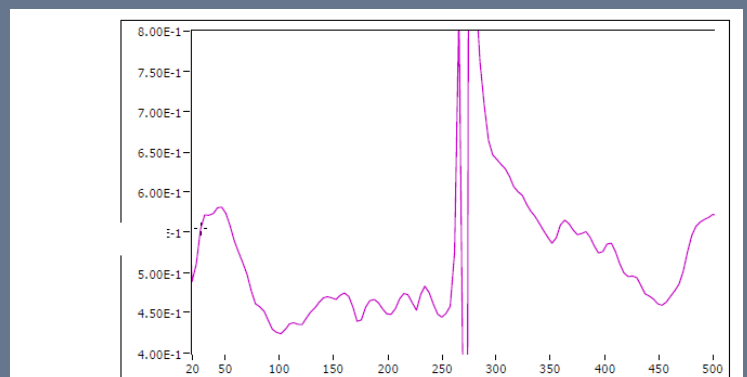
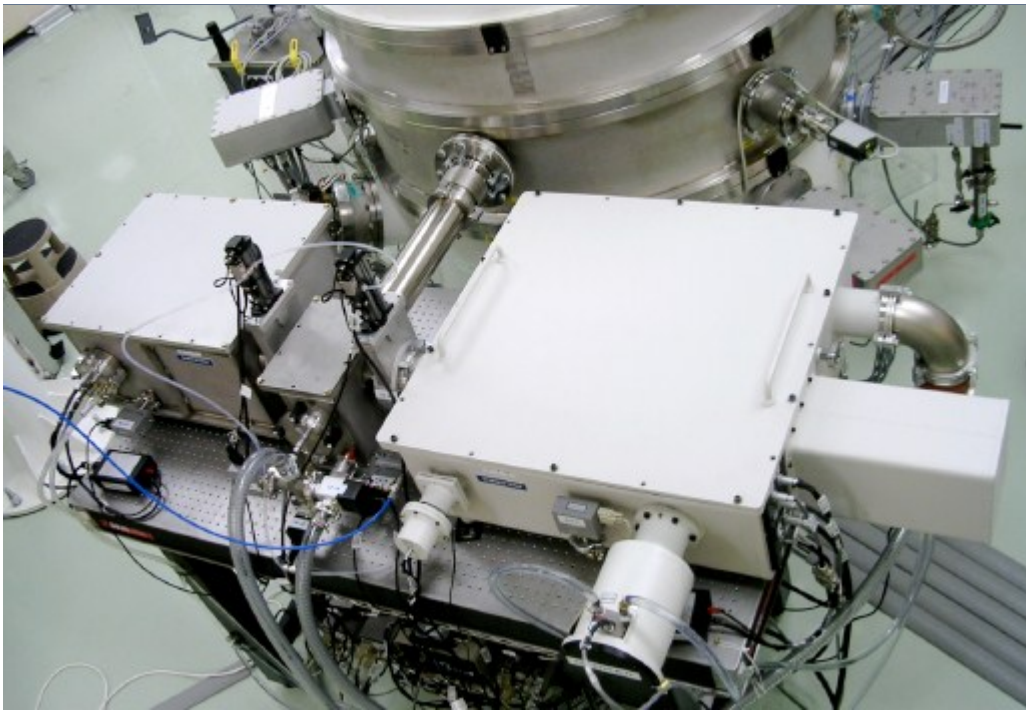

Figure 28 Germanium Reflectance, sample holder at 13° , swing arm at 25.5° (Home position) (measured at: Atmospheric pressure, Rapid scan, Michelson, Hg arc lamp 70W, Res. 10 cm^{-1})



Results

The calibration of the Planck/HFI instrument was carried in two phases, in November 2004 and June 2006. For the June 2006 phase, a polarising Fourier transform spectrometer, based on the Sciencetech Inc. SPS-200 was used as a modulated spectral source. The procurement from Sciencetech Inc. included this spectrometer, the optical components coupling the spectrometer to ESA's calibration facility, and an additional modulated continuum source. Due to the requirement of a space instrument environment, the operation of this system was done in a clean room (class 10 000). The contract was established between Sciencetech Inc., the Institut d'Astrophysique Spatiale and the European Space Agency as the funding agency.

Planck launched on 14 May 2009 on an Ariane 5 from ESA's Spaceport in Kourou, French Guiana. It shared a ride into orbit with ESA's Herschel spacecraft. The two spacecraft subsequently operated independently.

Planck operated from a Lissajous orbit around the second Lagrangian point of the Sun-Earth system (L2).

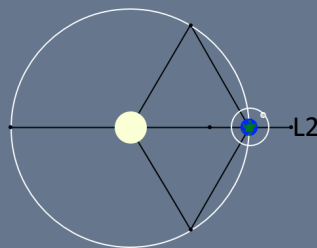

Software

The intelligent application of proven principles, techniques, languages, and tools to the cost-effective creation and maintenance of software that satisfies users' needs

Sciencetech's software Engineers follow the best practice to develop custom applications from the smallest GUI to server based automation used for automated test procedures.

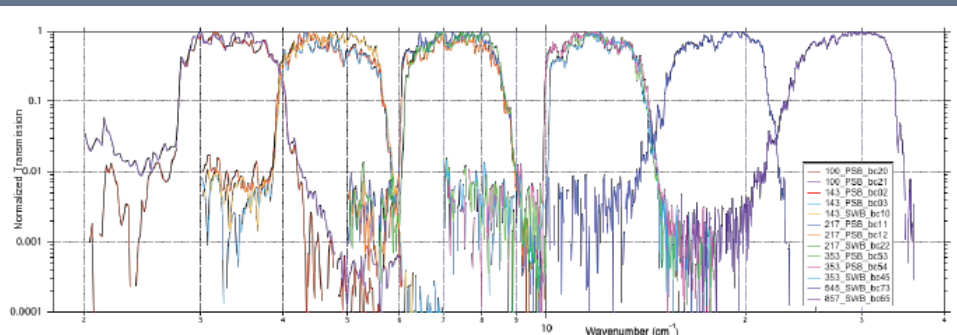

Planck/HFI spectral bands measured at LAS

Customer Satisfaction

End User Testimonial

In conclusion, after fruitful interactions, the spectrometers delivered are very well adapted to our needs, and show optical performances meeting our specifications. We had very good contact with the teams in charge of this project at Sciencetech Inc., and they offer a very satisfactory support.

With my best regards,



Francois Pajot
Scientific manager of the Planck/HFI instrument calibration

SCIENCETECH 

1450 Global Drive
London , Ontario
Canada, N6N 1R3
519-644-0135

www.sciencetech-inc.com